

RJ45 JACK MAGNETIC PCB T/H



MATERIAL

Insulator: Thermoplastic UL94V-0
 Contact: Phosphor Bronze
 Plated: Gold Plated over Nickel in contact
 Tin plated over Nickel in solder area
 Solder Pad: Brass with Tin plated over Nickel
 Shielded: Brass with Nickel plated

ELECTRICAL

Voltage Rating: 125 Vac Rms.
 Current Rating: 1.5 Amp.

MECHANICAL:

Operating: 750 Cycles Min.

ENVIRONMENTAL:

Storage: -40°C To +85°C.
 Operation: -20°C To +75°C.

243S

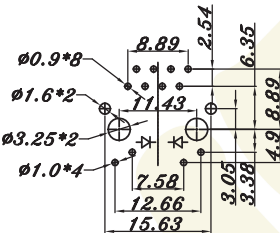
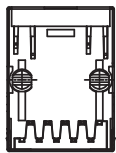
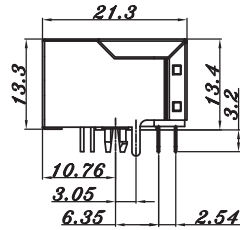
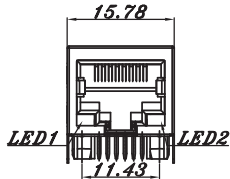

PCB LAYOUT/TOP VIEW

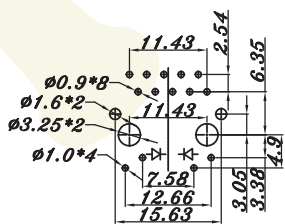
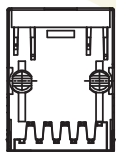
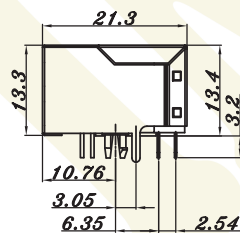
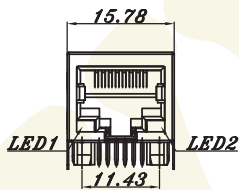
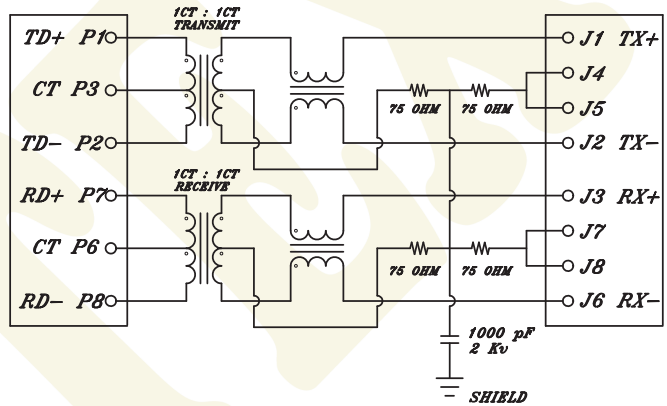

PCB LAYOUT/TOP VIEW

