

Pitch:1.0mm Pin Headers For PCB

**Special Options Contact Our Sales Team.*

MATERIAL

Insulator:Nylon UL94V-0 Black

Contact:Copper Alloy

SPECIFICATIONS

Current Rating:1A AC,DC

Withstanding Voltage:500V AC/minute

Insulation Resistance:1000MΩ Min.

Temperature Range:-55°C~+105°C

ORDER

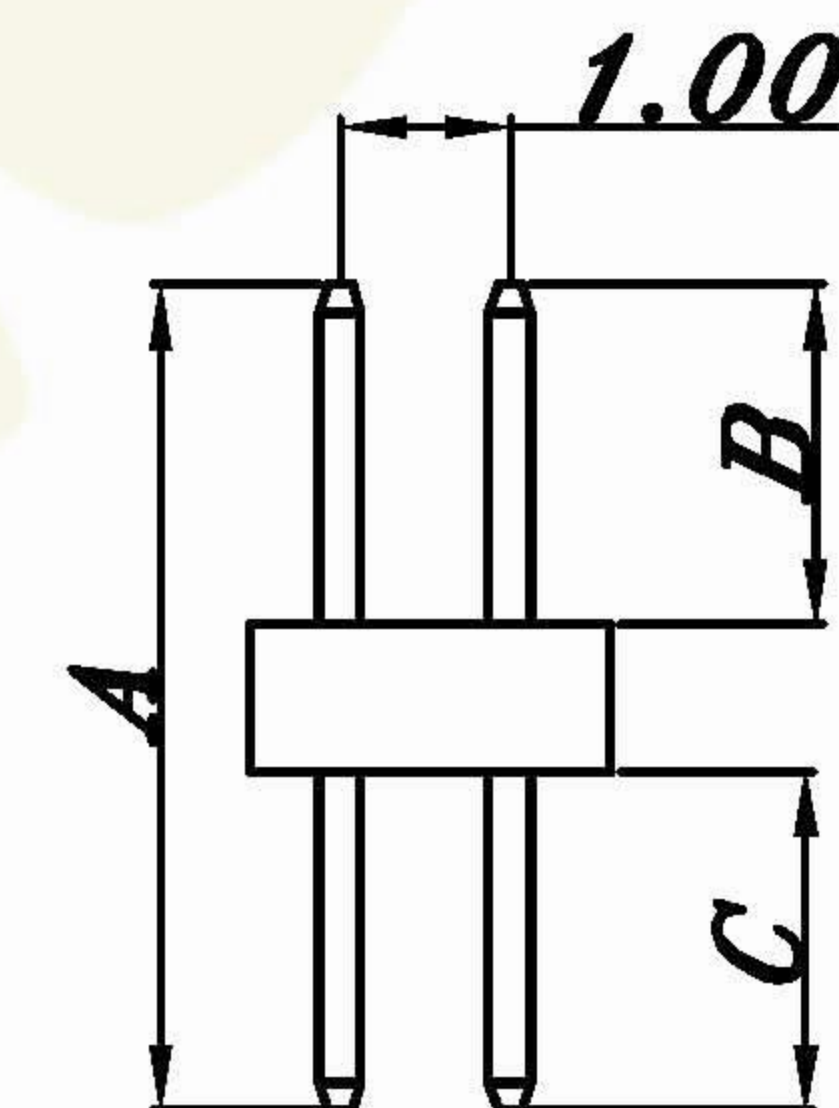
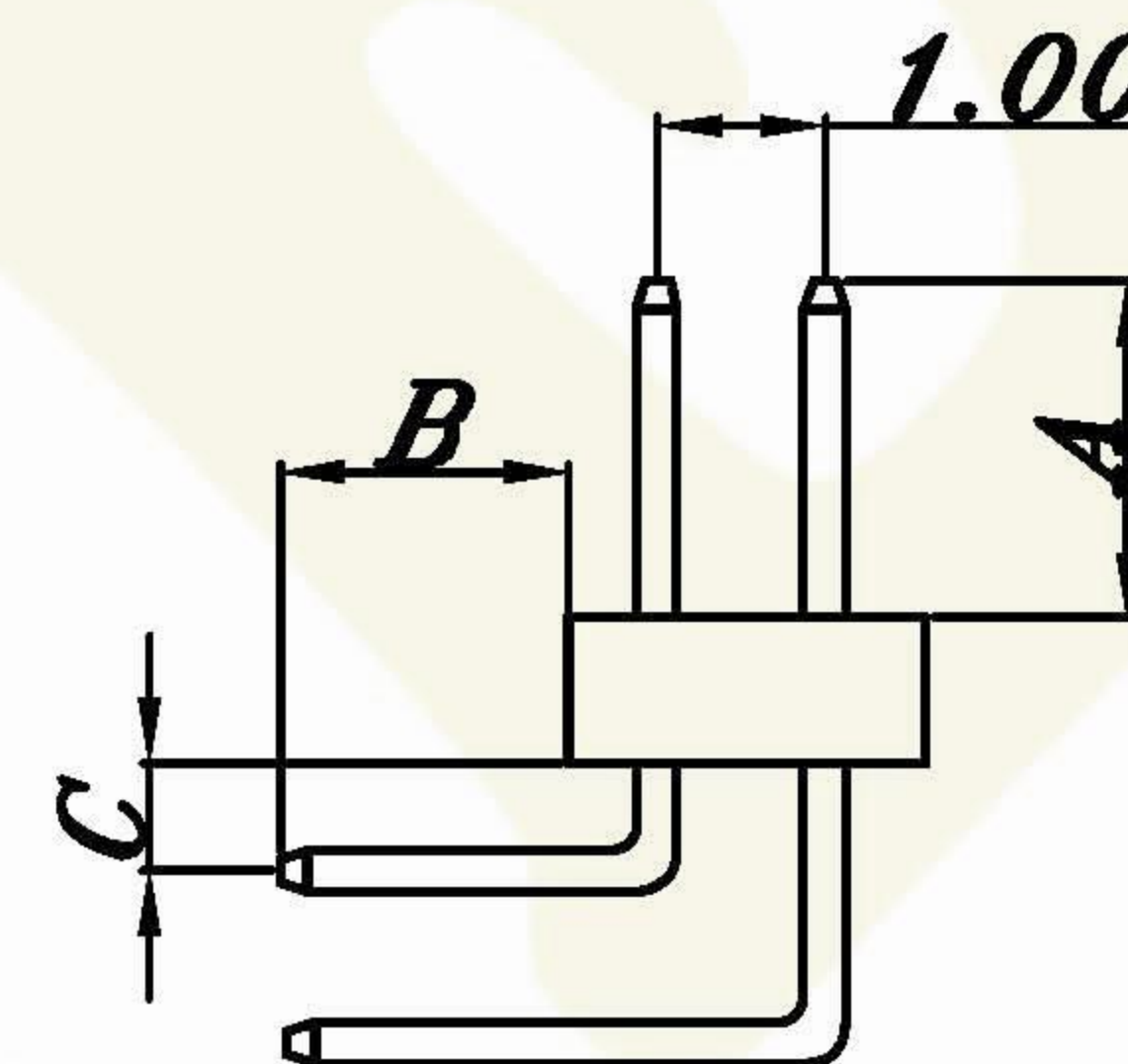
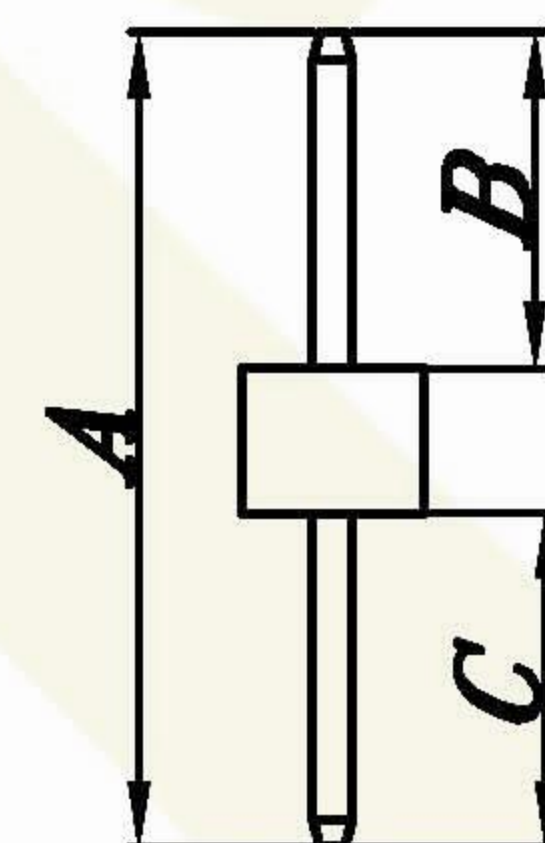
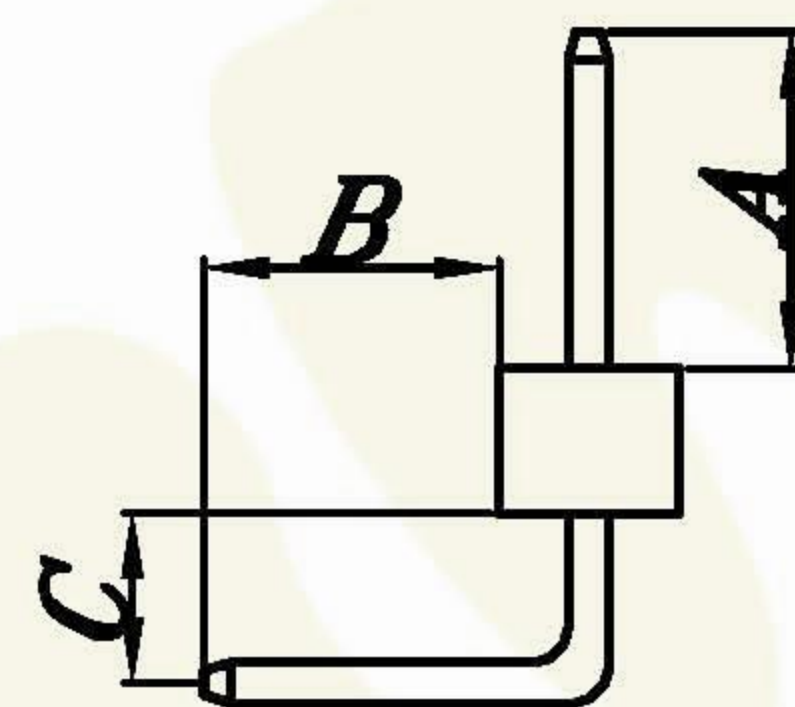
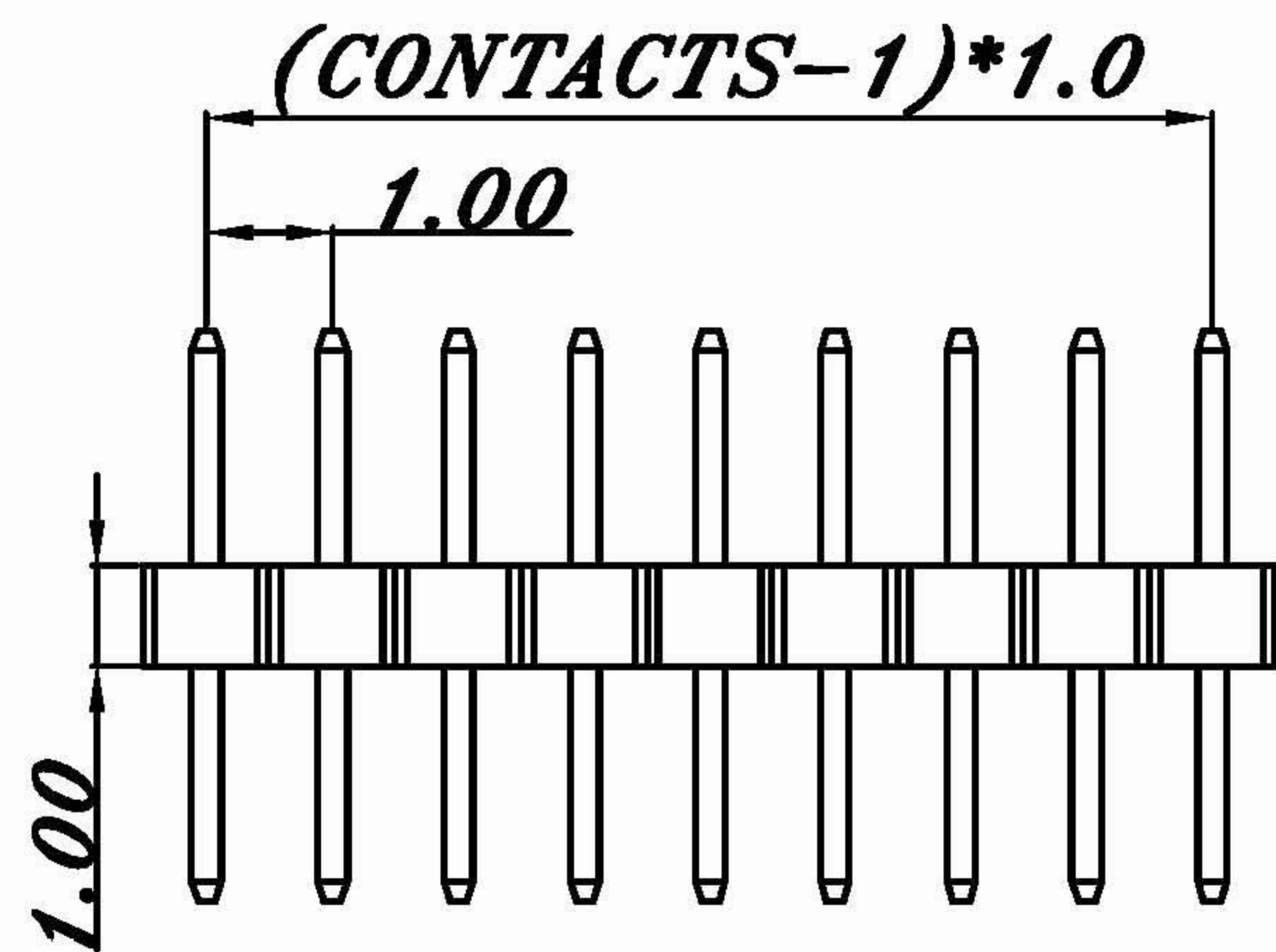
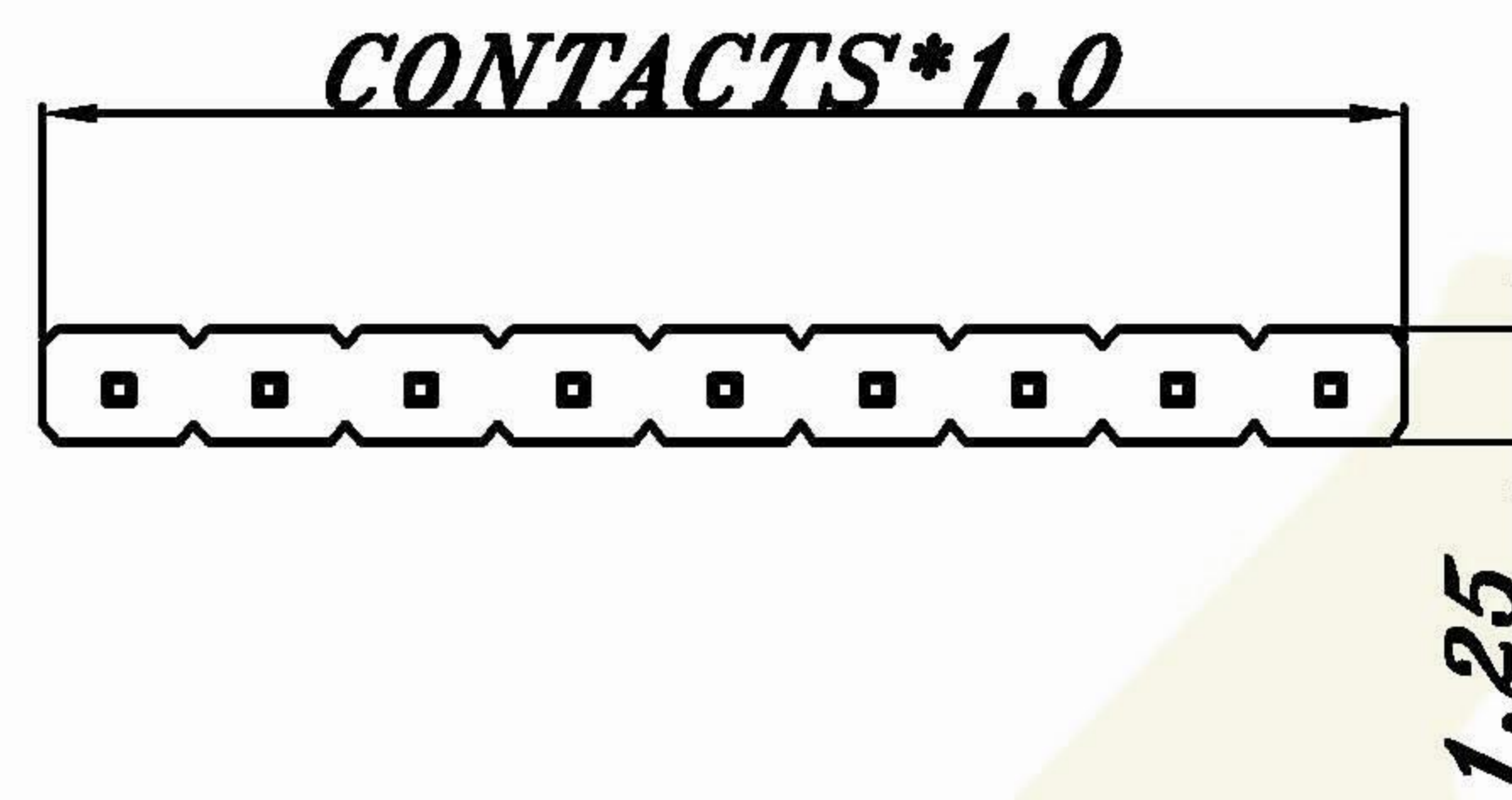
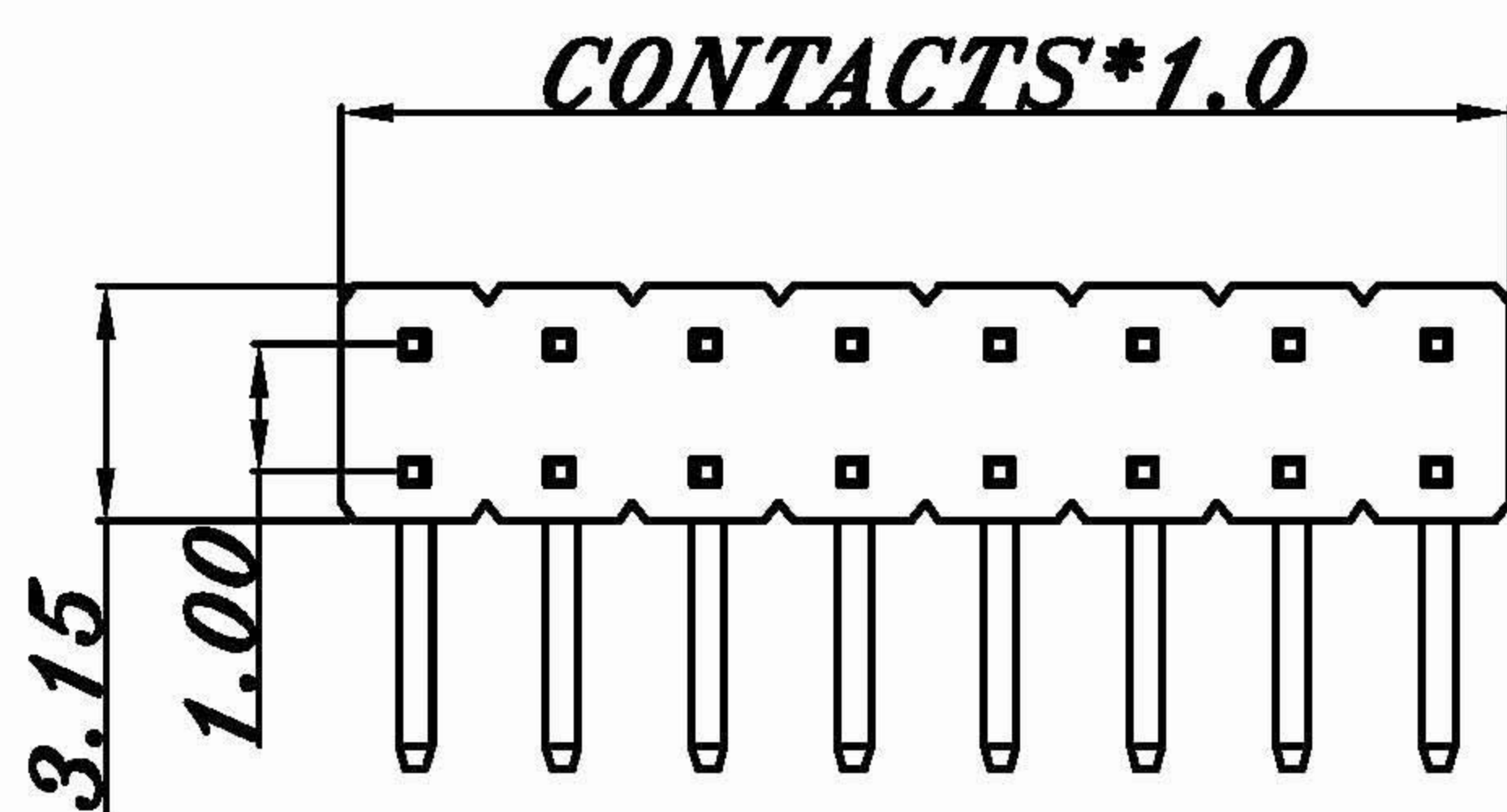
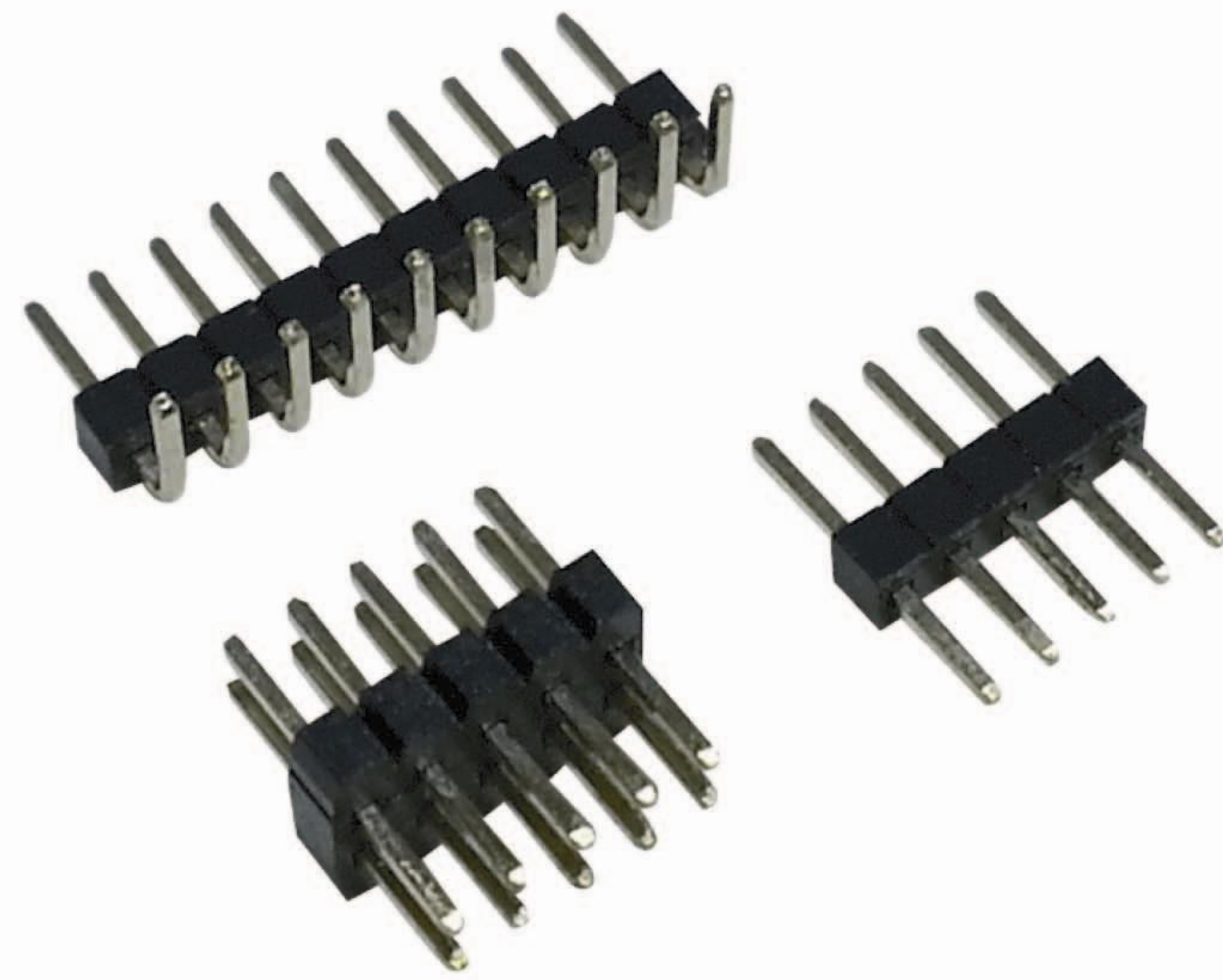
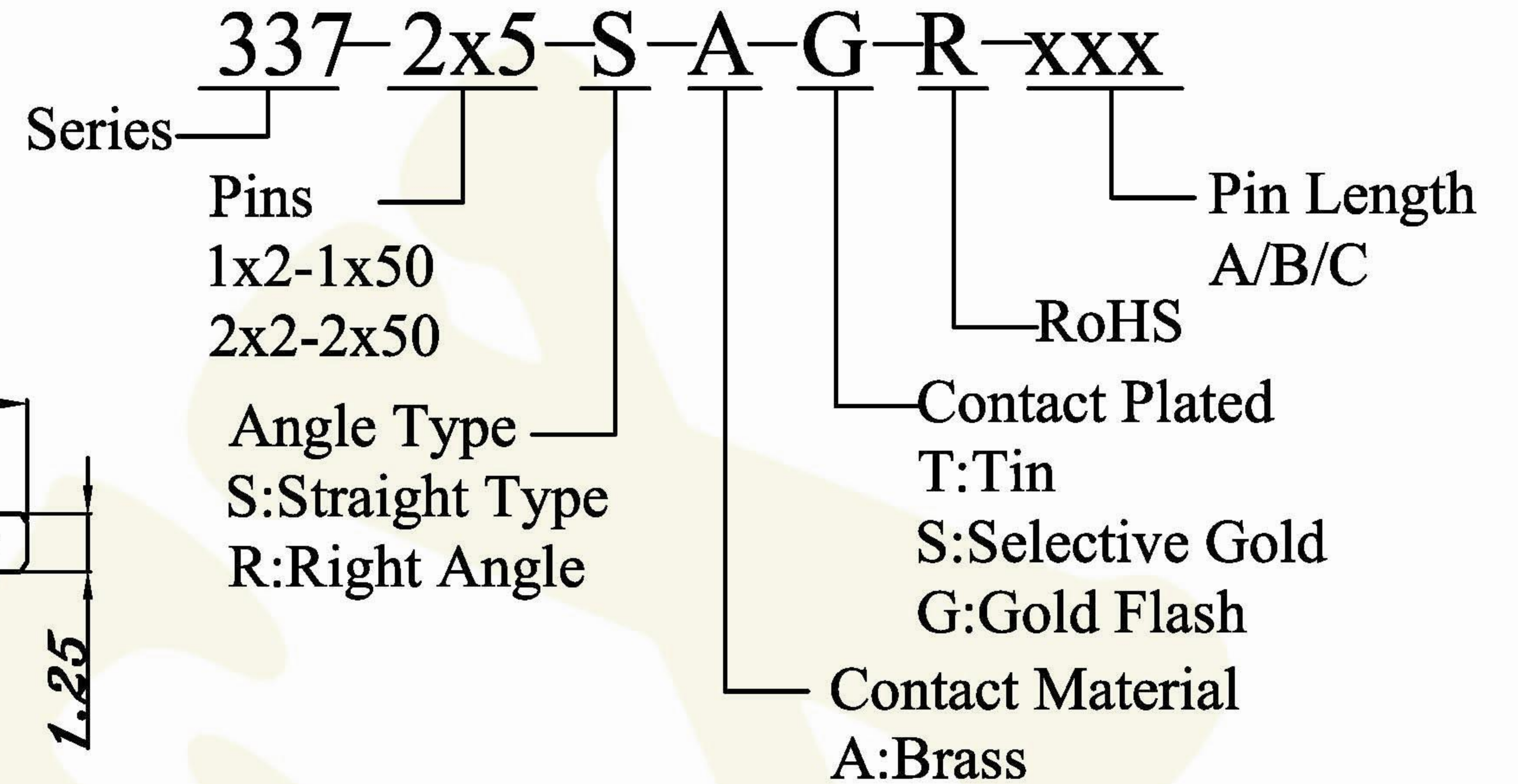

337